

Turmdrehkran

Tower Crane / Grue à tour / Gru a torre / Grúa torre
Guindaste de torre / Башенный поворотный кран

130 EC-B 8 FR.tronic®

130 EC-B 6

▶ **130 EC-B 8 FR.tronic®**

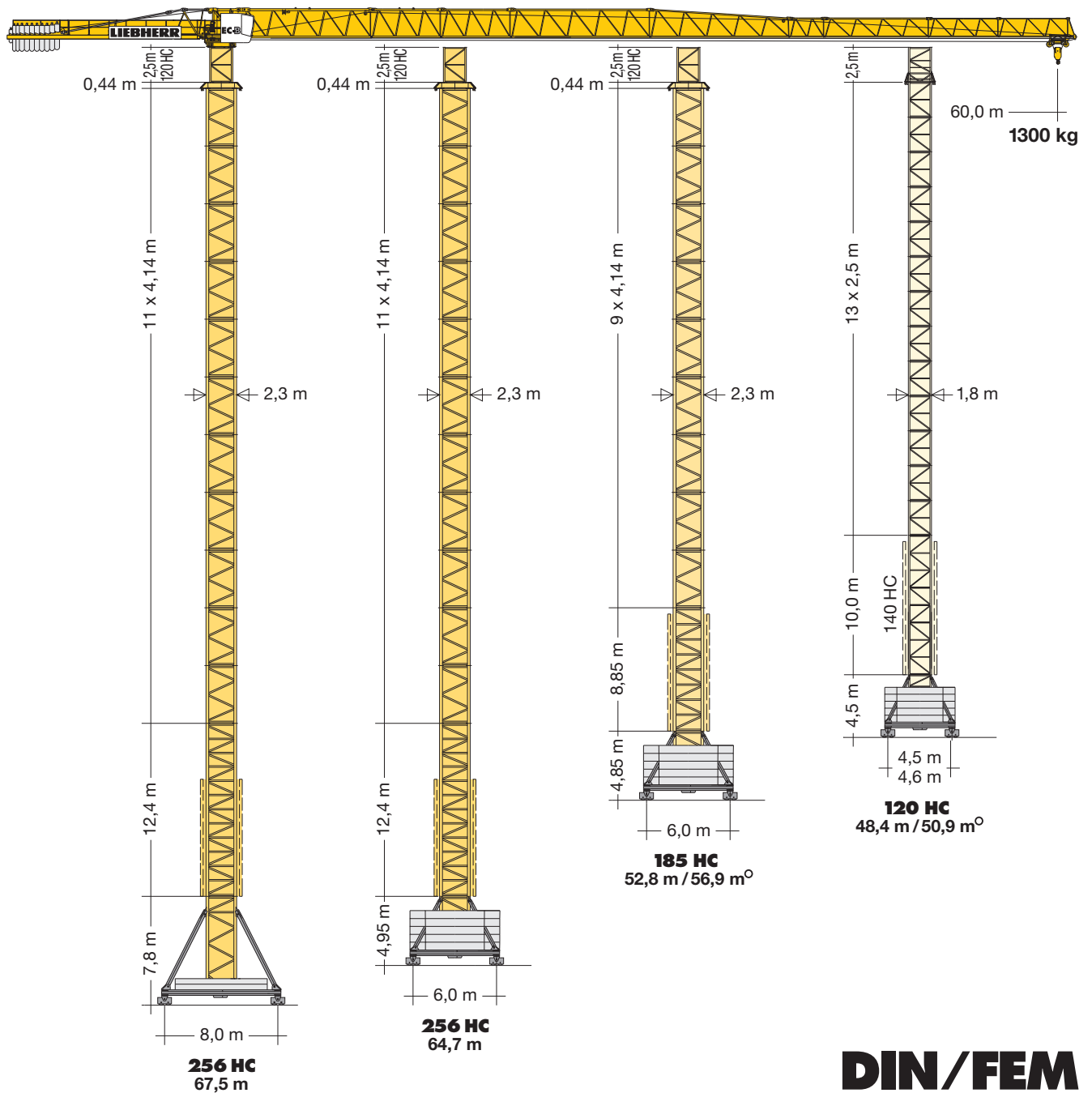

LIEBHERR

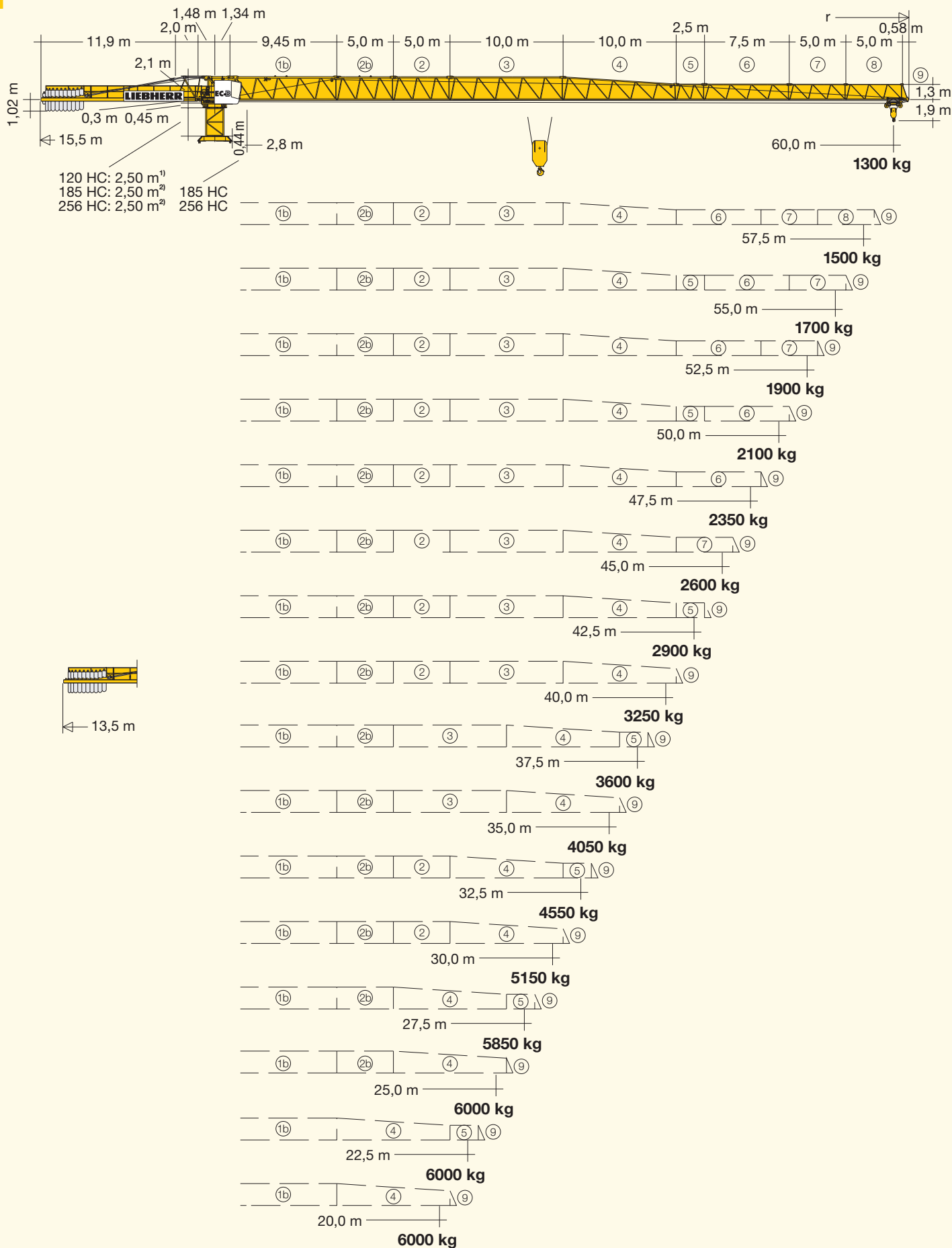

¹⁾ **Turmstück oder Kletterturmstück.** / Tower section or climbing tower section.
 Élément de mât ou élément de mât télescopable. / Elemento torre oppure elemento torretelescopabile. / Tramo torre o tramo torre trepable. / Segmento de torre ou segmento de torre para ascensão. / Башенная секция или секция наращивания

²⁾ **Turmstück 120 HC.** / Tower section 120 HC.
 Élément de mât 120 HC. / Elemento di torre 120 HC.
 Tramo torre 120 HC. / Segmento de torre 120 HC.
 Башенная секция 120 HC.

130 EC-B 8 FR.tronic®

m	r	m/kg	m/kg																		
			15,0	17,5	20,0	22,5	25,0	27,5	30,0	32,5	35,0	37,5	40,0	42,5	45,0	47,5	50,0	52,5	55,0	57,5	60,0
60,0	(r = 61,5)	2,8-13,9 8000	7340	6180	5320	4650	4110	3670	3310	3000	2730	2500	2300	2120	1970	1830	1700	1590	1480	1390	1300
57,5	(r = 59,0)	2,8-14,6 8000	7770	6550	5640	4940	4370	3910	3520	3200	2920	2680	2460	2280	2110	1960	1830	1710	1600	1500	
55,0	(r = 56,5)	2,8-15,3 8000	8000	6870	5920	5180	4590	4110	3710	3370	3070	2820	2600	2410	2230	2080	1940	1810	1700		
52,5	(r = 54,0)	2,8-15,8 8000	8000	7130	6140	5380	4770	4270	3860	3500	3200	2940	2710	2510	2330	2170	2030	1900			
50,0	(r = 51,5)	2,8-16,2 8000	8000	7330	6320	5540	4910	4400	3970	3610	3300	3040	2800	2600	2410	2250	2100				
47,5	(r = 49,0)	2,8-16,7 8000	8000	7610	6560	5750	5110	4580	4130	3760	3440	3170	2920	2710	2520	2350					
45,0	(r = 46,5)	2,8-17,1 8000	8000	7820	6750	5910	5250	4710	4260	3870	3550	3260	3010	2790	2600						
42,5	(r = 44,0)	2,8-17,6 8000	8000	8000	6970	6110	5430	4870	4400	4010	3670	3380	3130	2900							
40,0	(r = 41,5)	2,8-18,2 8000	8000	8000	7210	6330	5620	5050	4570	4160	3820	3510	3250								
37,5	(r = 39,0)	2,8-18,6 8000	8000	8000	7370	6470	5750	5170	4680	4260	3910	3600									
35,0	(r = 36,5)	2,8-19,1 8000	8000	8000	7620	6690	5950	5350	4840	4420	4050										
32,5	(r = 34,0)	2,8-19,6 8000	8000	8000	7840	6890	6130	5510	4990	4550											
30,0	(r = 31,5)	2,8-20,2 8000	8000	8000	8000	7100	6320	5680	5150												
27,5	(r = 29,0)	2,8-20,7 8000	8000	8000	8000	7310	6510	5850													
25,0	(r = 26,5)	2,8-19,3 8000	8000	8000	7680	6750	6000														
22,5	(r = 24,0)	2,8-17,3 8000	8000	7920	6840	6000															
20,0	(r = 21,5)	2,8-15,4 8000	8000	6960	6000																

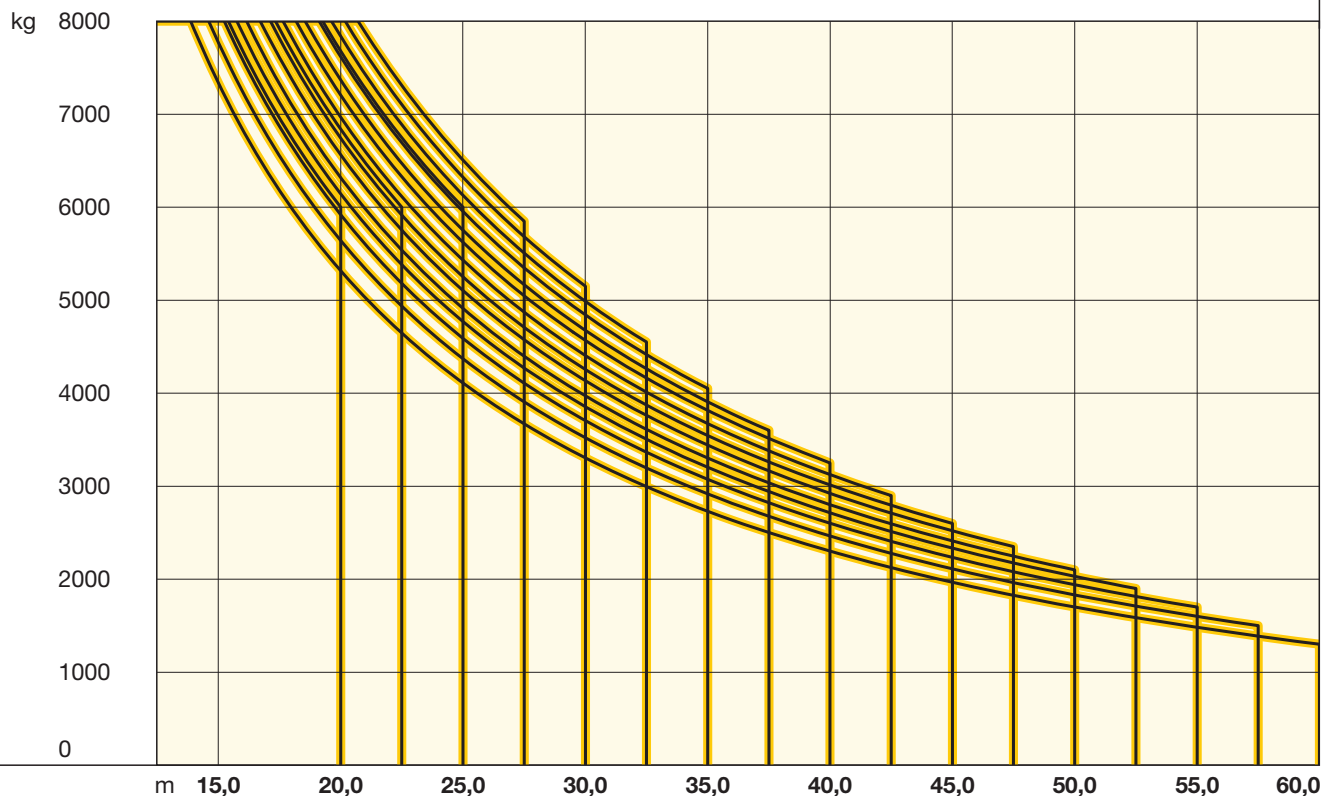

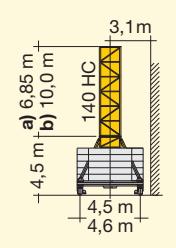
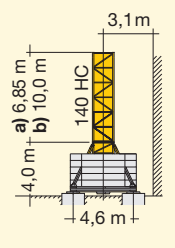
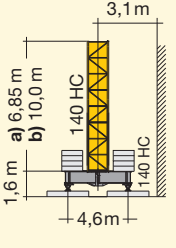
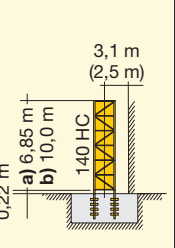
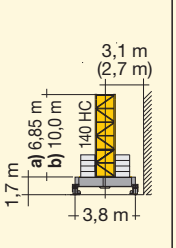
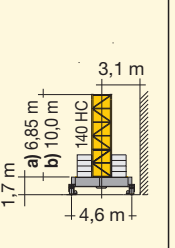
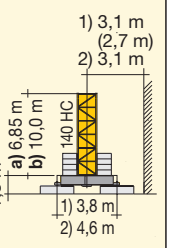

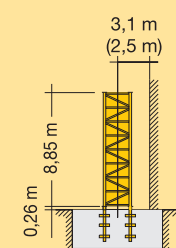
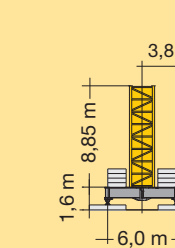
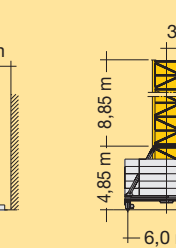
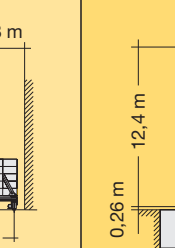
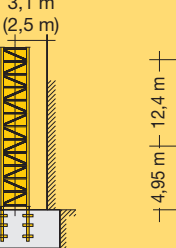
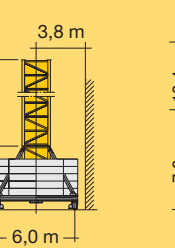

		120 HC												
14	47,7* ^o	50,9* ^o	47,2* ^o	50,4* ^o	44,8* ^o	48,0* ^o	43,4* ^o	46,6* ^o	-	-	-	-	-	-
13	45,2*	48,4*	44,7*	47,9*	42,3*	45,5*	40,9*	44,1*	-	-	42,4*	-	42,2*	-
12	42,7	45,9	42,2	45,4	39,8	43,0	38,4	41,6	39,9*	-	39,9	43,1*	39,7	42,9*
11	40,2	43,4	39,7	42,9	37,3	40,5	35,9	39,1	37,4	40,6*	37,4	40,6	37,2	40,4
10	37,7	40,9	37,2	40,4	34,8	38,0	33,4	36,6	34,9	38,1	34,9	38,1	34,7	37,9
9	35,2	38,4	34,7	37,9	32,3	35,5	30,9	34,1	32,4	35,6	32,4	35,6	32,2	35,4
8	32,7	35,9	32,2	35,4	29,8	33,0	28,4	31,6	29,9	33,1	29,9	33,1	29,7	32,9
7	30,2	33,4	29,7	32,9	27,3	30,5	25,9	29,1	27,4	30,6	27,4	30,6	27,2	30,4
6	27,7	30,9	27,2	30,4	24,8	28,0	23,4	26,6	24,9	28,1	24,9	28,1	24,7	27,9
5	25,2	28,4	24,7	27,9	22,3	25,5	20,9	24,1	22,4	25,6	22,4	25,6	22,2	25,4
4	22,7	25,9	22,2	25,4	19,8	23,0	18,4	21,6	19,9	23,1	19,9	23,1	19,7	22,9
3	20,2	23,4	19,7	22,9	17,3	20,5	15,9	19,1	17,4	20,6	17,4	20,6	17,2	20,4
2	17,7	20,9	17,2	20,4	14,8	18,0	13,4	16,6	14,9	18,1	14,9	18,1	14,7	17,9
1	15,2	18,4	14,7	17,9	12,3	15,5	10,9	14,1	12,4	15,6	12,4	15,6	12,2	15,4
0	12,7	15,9	12,2	15,4	9,8	13,0	8,4	11,6	9,9	13,1	9,9	13,1	9,7	12,9
	m a)	b)	m a)	b)	m a)	b)	m a)	b)	m a)	b)	m a)	b)	m a)	b)
														

		185 HC			256 HC													
12	-	-	-	64,1*	-	-												
11	-	-	-	60,0	64,7*	67,5*												
10	52,3* ^o	53,6* ^o	56,9* ^o	55,9	60,5	63,4												
9	48,2*	49,5*	52,8*	51,7	56,4	59,3												
8	44,0	45,5	48,6	47,6	52,3	55,1												
7	39,9	41,2	44,5	43,4	48,1	51,0												
6	35,7	37,1	40,3	39,3	44,0	46,8												
5	31,6	32,9	36,2	35,2	39,8	42,7												
4	27,5	28,8	32,1	31,0	35,7	38,6												
3	23,3	24,7	27,9	26,9	31,6	34,4												
2	19,2	20,5	23,8	22,7	27,4	30,3												
1	15,0	16,4	19,6	18,6	23,3	26,1												
0	10,9	12,2	15,5	14,5	19,1	22,0												
	m			m														
																		

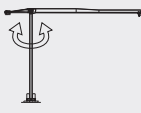
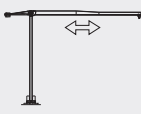
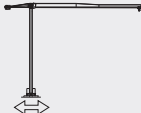
*  O = Ohne Kabine / Without cabin / Sans cabine / Senza cabina / Sin cabina / Sem cabine / Без кабины

Weitere Hubhöhen sowie Klettern auf Anfrage. / Further hoist heights and climbing on request. / Hauteurs sous crochet plus élevées et hissage sur demande. / Altre altezze di sollevamento come pure telescopaggio, su richiesta. / Para alturas bajo gancho superiores y trepado, consultar. / Outras alturas de elevação e ascensionamento, mediante consulta. / Другие высоты подъема и наращивание крана – по запросу.

	0 ↔ 0,8 U/min sl./min tr./min	7,5 kW FU
	0 ↔ 60,0 m/min	5,4 kW FU
	25,0 m/min	2 x 4,0 kW
	kVA	37 kW FU 47,0

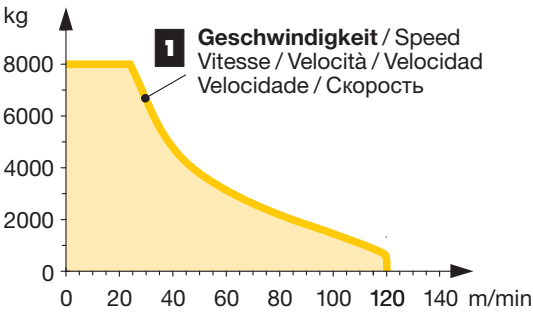



















	↔ stufenlos / stepless / régl. continu regl. progressiva / sin escalones / sem degraus бесступенчатый kg m/min
37 kW FU WIW 250 MZ 411	
	5 Lagen Layers Couches Avvolgimenti Camadas Capas Слоев
110,0 m	1 8000 0 ↔ 24 750 0 ↔ 120
190,0 m**	
	1 Geschwindigkeit / Speed Vitesse / Velocità / Velocidad Velocidade / Скорость

** Weitere Hublastdaten: siehe Betriebsanleitung. / Further hoist load data: see instruction manual. / Autres données de la charge de levage: voir manuel d'instruction. / Altri dati sui carichi sollevati: consultare il manuale d'istruzione. / Alturas bajo granchos superiores según manual. / Outras tabelas de carga: consultar manual de instruções. / Другие данные по весу поднимаемых грузов: см. инструкцию по эксплуатации.

Kolli-Liste

Packing List / Liste de colisage / Lista dei colli
Lista de contenido / Lista de embalagem / Упаковочный лист

Montagegewichte: siehe Betriebsanleitung. / Erection weights: see instruction manual. / Poids de montage: voir manuel de service. / Pesos di montaggio: vedere manuale d'uso. / Peso para el montaje: según manual. / Pesos de montagem: veja-se as instruções p. uso. / Масса монтируемых частей: см. инструкцию по эксплуатации.

Kranoberteil		Upper part of crane / Partie supérieure de grue / Parte superiore della gru Parte superior grúa / Parte superior do guindaste / Верхняя часть крана	L (m)	B (m)	H (m)	kg*		
Pos. Item	Anz. Qty.	Drehbühne mit Podesten / Slewing platform with platforms Plate-forme tournante avec plates-formes / Piattaforma girevole con pedana / Plataforma giratoria con plataforma Plataforma giratória com plataforma / Поворотная платформа с площадками			3,03	3,35	2,83 (2,51)	7810
1	1							
2	1	Drehbühne / Slewing platform / Ensemble mât-cabine / Piattaforma girevole / Conjunto plataforma de giro / Plataforma giratória Поворотная платформа			3,03	2,43	2,83 (2,51)	7380
3	1	Podeste / Platforms / Plates-formes Pedana / Plataformas / Plataformas Площадки			2,80 3,09 2,80	1,10 0,79 1,12	1,24 1,29 1,22	250 200 170
4	1	Kabine / Cabin / Cabine Cabina / Cabina / Cabina Кабина			3,57	1,38	2,27	690
5	1	Gegenausleger-Anlenkstück / Counter-jib heel section Pied de contre-flèche / Settore articolato di controbraccio Tramo primero-contrapluma / Base articulada da contra-lança Корневая секция консоли противовеса			2,75	1,20	2,25	760
6	1	Gegenausleger / Counter-jib / Contre-flèche Controfreccia / Contrapluma / Contra-lança Консоль противовеса			11,98	1,40	0,81	2700
7	1	Podeste Gegenausleger / Counter-jib platforms Plates-formes de contre-flèche / Ballatoi controfreccia Plataforma contrapluma / Plataforma contra-lança Площадки консоли противовеса			4,00	0,69	1,35	180
8	1	Ausleger-Anlenkstück / Jib heel section / Pied de flèche Sezione articolata braccio / Pluma tramo primero / Base articulada de lança / Корневая секция стрелы			9,67	1,34	2,25	⊗ 2270
9	1	Ausleger-Zwischenstück / Intermediate jib section Élément intermédiaire de flèche / Sezione intermedia braccio / Tramo intermedio pluma / Peça suplementar da lança / Промежуточная секция стрелы			5,26 5,27 10,26 2,72 7,71 5,19 5,17	1,20 1,20 1,20 1,20 1,20 1,20 1,20	2,15 2,15 2,14 1,48 1,48 1,46 1,45	⊗ 850 ⊗ 760 ⊗ 1170 ⊗ 200 ⊗ 520 ⊗ 240 ⊗ 200
10	1	Ausleger-Zwischenstück / Intermediate jib section Élément intermédiaire de flèche / Sezione intermedia braccio / Tramo intermedio pluma / Peça suplementar da lança / Промежуточная секция стрелы			10,22	1,20	2,08	⊗ 900

Pos. Item Rep. Voce Pos. Ref. Поз.	Anz. Qty. Qte. Qta. Cant. Cant. Кол-во				L (m)	B (m)	H (m)	kg*
11	1	Ausleger-Kopfstück / Jib head section / Pointe de flèche / Punta braccio / Tramo punta de pluma / Cabeça de lança / Концевая секция стрелы			1,40	1,21	0,46	85
12	1	Laufkatze / Trolley / Chariot / Carrello / Carrito / Carrinho / Грузовая тележка			1,62	1,38	1,29	550
13	1	Fahrkorb / Maintenance cage / Nacelle d'entretien / Cestello di manutenzione / Plataforma de mantenimiento / Передвижная платформа			0,78	0,66	1,25	35
Turm Tower / Mât / Torre / Torre / Башня								
14	15	Turmstück / Tower section			120 HC 2,50	1,80	1,80	1090
	10	Elément de mât / Elemento di torre			185 HC 4,14	2,30	2,30	2240
	12	Tramo torre / Torre / Башенная секция			256 HC 4,14	2,30	2,30	2300
15	7	Turmstück lang / Long tower section / Elément de mât long / Elemento di torre, lungo / Tramo de torre largo			120 HC 5,00	1,80	1,80	1830
	3	Peça de torre, comprida / Башенная секция, длинная			120 HC 10,00	1,80	1,80	3430
					120 HC 12,50	1,80	1,80	4200
16	1	Grundturmstück / Base tower section / Mât de base / Elemento di torre base / Tramo base / Peça de base de torre / Секция основания			140 HC 6,85	1,80	1,80	2930
					140 HC 10,00	1,80	1,80	3990
					185 HC 8,85	2,30	2,30	4280
					256 HC 8,85 (12,42)	2,30 (2,30)	2,30 (2,30)	4830 (7940)
17	1	Kletterturmstück / Climbing tower section / Elément de hissage de mât / Elemento torre di telescopaggio / Tramo de trepado / Tramo de telescopagem / Секция самоподъема			120 HC 2,75	2,20	2,45	1450
Klettereinrichtung Climbing equipment / Equipement de télescope / Attrezzatura per allungamento della gru / Equipo de trepado / Acessórios p. subida no edifício / Обойма наращивания								
18	1	Führungsstück kpl. / Guide section cpl. / Cage télescopique cpl. / Gabbia di sopraelevazione compl. / Torre de montaje completa / Peça de guia compl. / Направляющая секция в сб.			120 HC 6,45	2,10	2,42	3500
					120 HC 9,60	2,10	2,42	4440
					185 HC 8,39	2,68	2,58 (3,04)	5200
					256 HC 8,39	2,68	2,58 (3,04)	5200
19	1	Hydraulikanlage, Stütz- und Klettertraverse / Hydraulic unit, supporting and climbing cross members / Système hydraul. avec traverses d'appui et de télescope. / Sist. idraul., travessa di appoggio e allugam. gru / Sistema hidráulico con traviesa de apoyo y trepado / Instalação hidráulica, travessa de apoio e subida / Гидроагрегат, стойка-упор и траверса обоймы наращивания			120 HC 2,87	2,12	1,06	1050
					185 HC 2,30	1,25	1,00	1150
					256 HC 2,30	1,25	1,00	1150
Unterwagen Undercarriage / Châssis / Carro / Carro con mástil / Carro de guindaste / Опорная рама								
20	2	Fahrschemel mit Antrieb / Rail bogie with drive / Bogie moteur / Telaço con grúpa propulsore / Caja rodillo motriz / Quadra sem grúpa de propulsão / Подрамник с приводом			120 HC 1,38	0,88	0,87	900
					185 HC 1,46	0,84	0,87	920
					256 HC 1,63 (1,46)	0,92 (0,84)	0,95 (0,87)	1690 (920)
21	2	Fahrschemel ohne Antrieb / Rail bogie without drive / Bogie fou / Telaço senza grúpa propulsore / Caja rodillo conducido / Quadra com grúpa de propulsão / Подрамник без привода			120 HC 1,17	0,60	0,87	860
					185 HC 1,15	0,60	0,87	880
					256 HC 1,37 (1,15)	0,62 (0,60)	0,95 (0,87)	1340 (880)
22	1	Tragholm lang / Long support arm / Longeron long / Longherone lungo / Brazo soporte largo / Travessa comprida / Несущая балка, длинная			120 HC 7,12	0,78	0,65	950
					185 HC 9,10	0,82	0,74	1350
					256 HC 9,10 (11,95)	0,80 (0,82)	0,80 (0,80)	1650 (2200)
23	2	Tragholm kurz / Short support arm / Longeron court / Longherone corto / Brazo soporte corto / Travessa curta / Несущая балка, короткая			120 HC 3,45	0,56	0,55	408
					185 HC 4,41	0,62	0,71	615
					256 HC 4,45 (5,58)	0,77 (0,65)	0,77 (0,77)	800 (1035)
24	2 + 2	Randträger / Border support / Traverse / Supporti base / Travessa / Apoio de bordo / Стяжная балка			120 HC 4,02	0,35	0,12	95
					185 HC 5,48 - 5,46	0,11 - 0,17	0,16 - 0,38	118 - 454
					256 HC 5,46 - 5,40	0,11 - 0,18	0,16 - 0,38	175 - 525
					(7,52 - 7,46)	(0,10 - 0,17)	(0,10 - 0,38)	(366 - 912)
25	4	Stützholm / Support strut / Hauban de châssis / Correnti di appoggio / Tirante vertical / Travessa de apoio / Опорный подкос			120 HC 3,78	0,15	0,22	200
					185 HC 4,23	0,17	0,25	275
					256 HC 4,14 (6,55)	0,18 (0,22)	0,25 (0,25)	320 (600)
26	1	Unterwagen-Turmstück / Undercarriage tower section / Mât de châssis / Elemento di torre del carro / Tramo de carro / Peça de torre do chassis / Опорная башенная секция			120 HC 3,50	2,06	2,06	1320
					185 HC 3,73	2,52	2,52	1950
					256 HC 3,73 (6,70)	2,62 (2,53)	2,62 (2,53)	2550 (3800)
27	1	Stapel Aufstiege und Podeste / Bundle of ladders and platforms / Faisceau d'échelles et de plates-formes / Serie di scale e rampe / Paquete de escaleras y plataformas / Escadas e patamares / Лестницы и площадки			120 HC 3,50	1,20	1,00	1000
28	1	Kiste mit Kleinteilen / Crate with small parts / Caisse contenant des accessoires / Cassa con accessori / Caja con accesorios / Caixa de acessórios / Ящик с мелкими деталями			2,00	1,00	1,00	2000

() **Angaben in Klammern gelten für 8 m-Unterwagen.** / The data in brackets are valid for an undercarriage of 8 m. / Les données techniques indiquées entre parenthèses sont valables pour un châssis de 8 m. / Caratteristiche in (.) valgono per carro di 8 m. / Los datos entre paréntesis son válidos para carro de 8 m. / Características em (.) válidas pelo chassis de 8 m. / Данные в скобках относятся к 8-метровой опорной раме.

* **Einzelgewichte.** / Single weights. / Poids individuels. / Singoli pesi. / Pesos unitarios. / Pesos de peças componentes. / Индивидуальный вес.

Konstruktionsänderungen vorbehalten! / Subject to alterations! / Sous réserves de modifications! / Reservato il diritto di modifiche strutturali! / ¡Sujeto a modificaciones! / Salvo modificação da construação! / Права на внесение конструкторских изменений сохраняются!

Sämtliche Angaben erfolgen ohne Gewähr. / This information is supplied without liability. / Ces renseignements sont sans garantie. / Tutte le indicazioni fornite senza garanzia. / Declinamos toda responsabilidad derivada de la información proporcionada. / Declinamos qualquer responsabilidade quanto à informação fornecida. / Все данные указаны без обязательств.

121 P - 5573 H1 B3 DIN 15018 • BGL C.0.10.0125 / FEM (Section 1) - Krangruppe A3 • 04.13 / 7

Printed in Germany.